

INSTALLATION AND OPERATION GUIDE FOR

HARGROVE

Glass H-Tube and Stainless Steel “S” Burner



Installation and service must be provided by a qualified installer, service agency or the gas supplier.

NOTE: ADEQUATE FIREPLACE VENTILATION IS REQUIRED FOR SAFETY
READ INSTRUCTIONS FULLY BEFORE INSTALLING OR OPERATING
INSTALLER: LEAVE THESE INSTRUCTIONS WITH CONSUMER!

The gas appliance must be burned only in a fully vented, non-combustible fireplace with the **damper completely open** and the chimney free of any obstructions or restrictions. The fireplace must be designed and approved to burn wood.

The realistic yellow flame produces carbon monoxide and soot. Under normal conditions, these products are exhausted up the chimney. If fumes or soot, from the gas burning, are evident in the room when the damper is fully open it indicates that the fireplace draft is defective. Do not operate your gas appliance until the fireplace draft is corrected.

FOR YOUR SAFETY

Do not store or use gasoline or other flammable vapors and liquids in the vicinity of this or any other appliance.

WARNING: If the information in this manual is not followed exactly, a fire or explosion may result causing property damage, personal injury or loss of life.

It is the homeowner's responsibility to assure their fireplace has adequate draft.

FOR YOUR SAFETY

WHAT TO DO IF YOU SMELL GAS

1. Do not try to light any appliance.
2. Do not touch any electrical switch; do not use the phone in your building.
3. Immediately call your gas supplier from a neighbor's phone. Follow the gas supplier's instructions.
4. If you cannot reach your gas supplier, call the fire department.

IMPORTANT INFORMATION

WARNING: This appliance assembly contains burner orifices specifically for the input gas and Btu rating. Modifying or failure to use the factory orifice may cause property damage, personal injury or loss of life.

1. Do not use a natural gas set for propane or a propane set for natural gas.
2. There are many different local codes for gas appliances. The installation and the provision for combustion and ventilation air must conform to local codes and, or in the absence of local codes, with the National Fuel Gas Code ANSI Z223.1 – (most current revision).
3. Gas appliances must be installed by personnel qualified for installing gas appliances.
4. This appliance must be installed only in a solid-fuel burning fireplace with a working flue and constructed of noncombustible materials. Solid fuels are not to be burned in a fireplace where a decorative appliance has been installed.
5. A permanent free opening must be provided by either the fireplace chimney or chimney damper to vent flue gasses. Any chimney damper must be fixed in a manner, which will maintain the permanent free opening at all times. Use Table II to determine the minimum permanent free opening based on chimney height and the appliance Btu input rating. Refer to the Damper Stop section for additional directions.
6. The minimum free opening is based only on two factors; chimney height and Btu input rating. Many other factors affect the fireplace drafting. It is the homeowner's responsibility to assure their fireplace has adequate draft. If fumes or soot from the gas burning are evident in the room when the damper is fully open, it indicates that the fireplace draft is defective. Do not operate your gas appliance until the fireplace draft is corrected. Consult your fireplace specialist.
7. A fireplace screen must be in place when the appliance is operating and, unless other provisions for combustion air are provided, the screen shall have an opening(s) for introduction of combustion air.
8. When glass fireplace doors are used, always operate your gas appliance with the doors fully open to allow for proper combustion air and to keep control valves from overheating.
9. The minimum inlet supply pressure for the purpose of input adjustment is 5.0 inches (natural gas) 11 inches (propane gas) in water column. The maximum inlet supply pressure is 10.5 inches (natural gas) 13 inches (propane gas) in water column.
10. The appliance and its individual shut-off valve must be disconnected from the gas supply piping system during any pressure testing of that system at test pressures in excess of 1/2 psig (3.5kPa). The appliance must be isolated from the gas supply piping system by closing its individual manual valve during pressure testing equal to or less than 1/2 psig (3.5kPa).
11. The fireplace chimney or venting system should be examined annually and cleaned as required by a qualified agency.

FIREPLACE SIZES

Each gas appliance requires a minimum 16-inch front opening height and minimum 16-inch depth. To determine the largest set that will fit in a fireplace, the width at the center of the fireplace is the critical dimension. Table I below indicates the minimum center width for each size set.

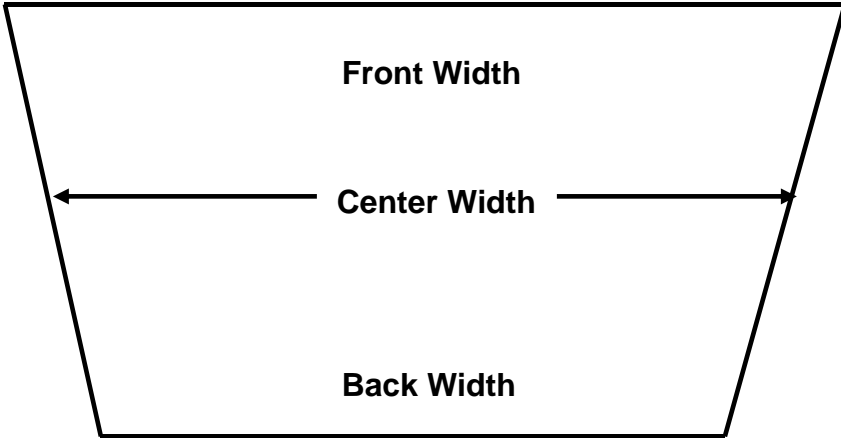

*View is looking down on the fireplace floor. To determine center width, add front width and back width and divide by 2.

<u>Set Size</u>	<u>Minimum Center Width</u>	<u>Minimum Front Opening Width</u>	<u>Minimum Depth</u>	<u>Minimum Height</u>
21	28"	30"	16"	16"
24	32"	36"	16"	16"
30	37"	42"	16"	16"

TABLE II

Free opening area of chimney damper for venting combustion products from decorative appliances for installation in vented fireplaces. Minimum size of chimney flue is 8" diameter.

Minimum Permanent Free Opening, Square Inches

Chimney Height, Feet	29	39	51	64
	Appliance Input Rating, Btu Per Hour (w)			
6	34,000	46,400	62,400	80,000
8	37,000	50,400	68,000	86,000
10	40,400	55,800	74,400	96,400
15	44,600	62,400	84,000	108,800
25	50,400	68,400	94,000	122,200
30	55,200	76,800	105,800	138,600

INSTALLING GLASS H-TUBE

PARTS LIST

<u>ITEM DESCRIPTION</u>	<u>18SNHT0A0</u>	<u>24SNHT0A0</u>	<u>30SNHT0A0</u>	<u>36SNHT0A0</u>
1. H-Tube	SSHB18	SSHB24	SSHB30	SSHB36
2. Sand	SD	SD	SD	SD
3. Flex connector	FCNW-18	FCNW-18	FCNW-18	FCNW-18
4. Brass reducing union	46-6-8	46-6-8	46-6-8	46-6-8
5. Brass reducing elbow	50-6-8	50-6-8	50-6-8	50-6-8
6. Volcanic cinders (3/8")	VC	VC	VC	VC
7. Damper stop	DS	DS	DS	DS



NATURAL GAS AND MATCH LIGHT ONLY

1. Make sure gas is shut off.
2. Connect the 1/2" to 3/8" brass reducing elbow (5) to your gas supply.
3. Connect the black flex connector (3) to the elbow (5).
4. Connect the 1/2" to 3/8" brass reducer (4) to the H-tube (1).
5. **Make sure that the H-tube has the holes facing down.** This will keep the sand from obstructing the holes. This will not affect flame height.
6. Finally, connect the flex connector (3) to the brass reducer (4).

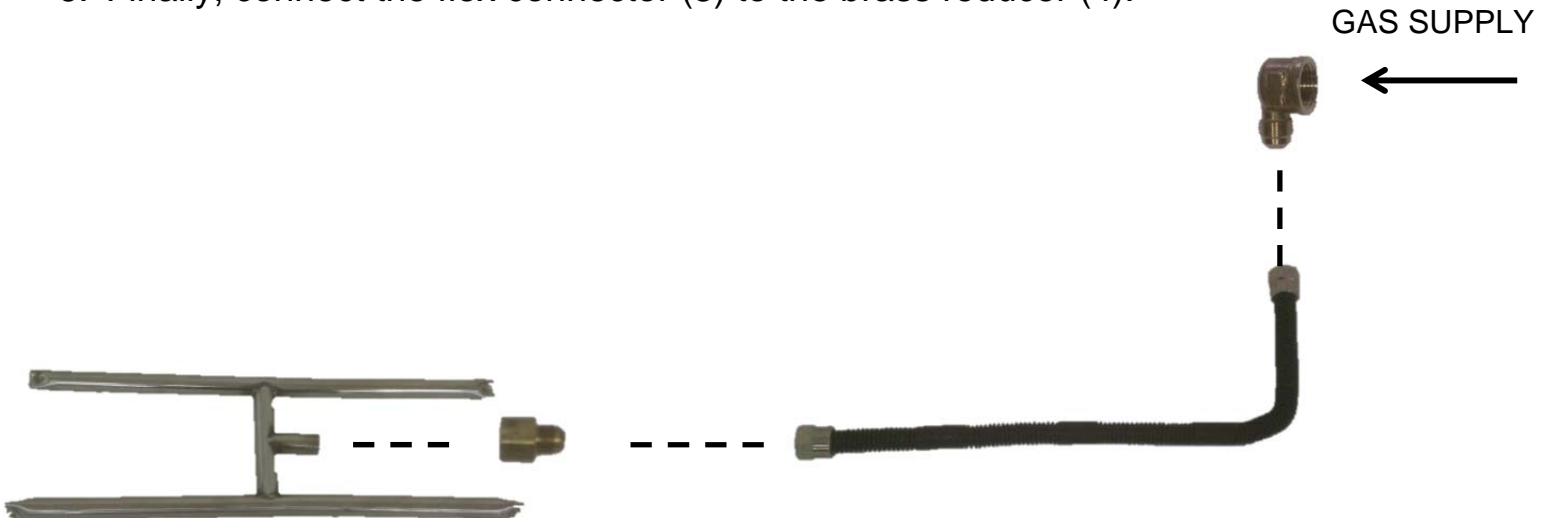

INSTALLING STAINLESS STEEL "S" BURNER

PARTS LIST FOR NATURAL GAS WITH NO VALVE

<u>ITEM DESCRIPTION</u>	<u>18SNSB0A0</u>	<u>24SNSB0A0</u>	<u>30SNSB0A0</u>
1. S-Burner	SSSB18	SSB24	SSB30
2. Black pipe cap	CAP-8	CAP-8	CAP-8
3. Sand	SD	SD	SD
4. Flex connector	FCNW-18	FCNW-18	FCNW-18
5. Brass reducing elbow	50-6-8	50-6-8	50-6-8
6. Brass reducing union	46-6-8	46-6-8	46-6-8
7. Volcanic cinders (3/8")	VC	VC	VC
8. Damper stop	DS	DS	DS



1. Make sure gas is shut off.
2. Connect black pipe cap (2) to the side of the burner you are not running gas to.
3. Connect either the brass reducing elbow (5) or brass reducing union (6) to the side of the burner that is not capped.
4. Connect the other brass reducer to your gas supply.
5. Use the flex connector (4) to connect the two reducers.
6. Finally, make sure that all of your connections are tight before lighting.

INSTALLING STAINLESS STEEL "S" BURNER

PARTS LIST FOR NATURAL GAS WITH VALVE

<u>ITEM DESCRIPTION</u>	<u>18SNSB1B0</u>	<u>24SNSB1B0</u>	<u>30SNSB1B0</u>
1. S-Burner	SSSB18	SSSB24	SSSB30
2. Black pipe cap	CAP-8	CAP-8	CAP-8
3. Valve	CPC-C	CPC-C	CPC-C
4. Control knob	SPC-K	SPC-K	SPC-K
5. Thermocouple and pilot	RSTPB-18	RSTPB-18	RSTPB-18
6. Sand	SD	SD	SD
7. Flex connector	FCNW-18	FCNW-18	FCNW-18
8. Brass reducing elbow	50-6-8	50-6-8	50-6-8
9. Brass reducing union	46-6-8	46-6-8	463-6-8
10. Volcanic cinders (3/8")	VC	VC	VC
11. Damper stop	DS	DS	DS

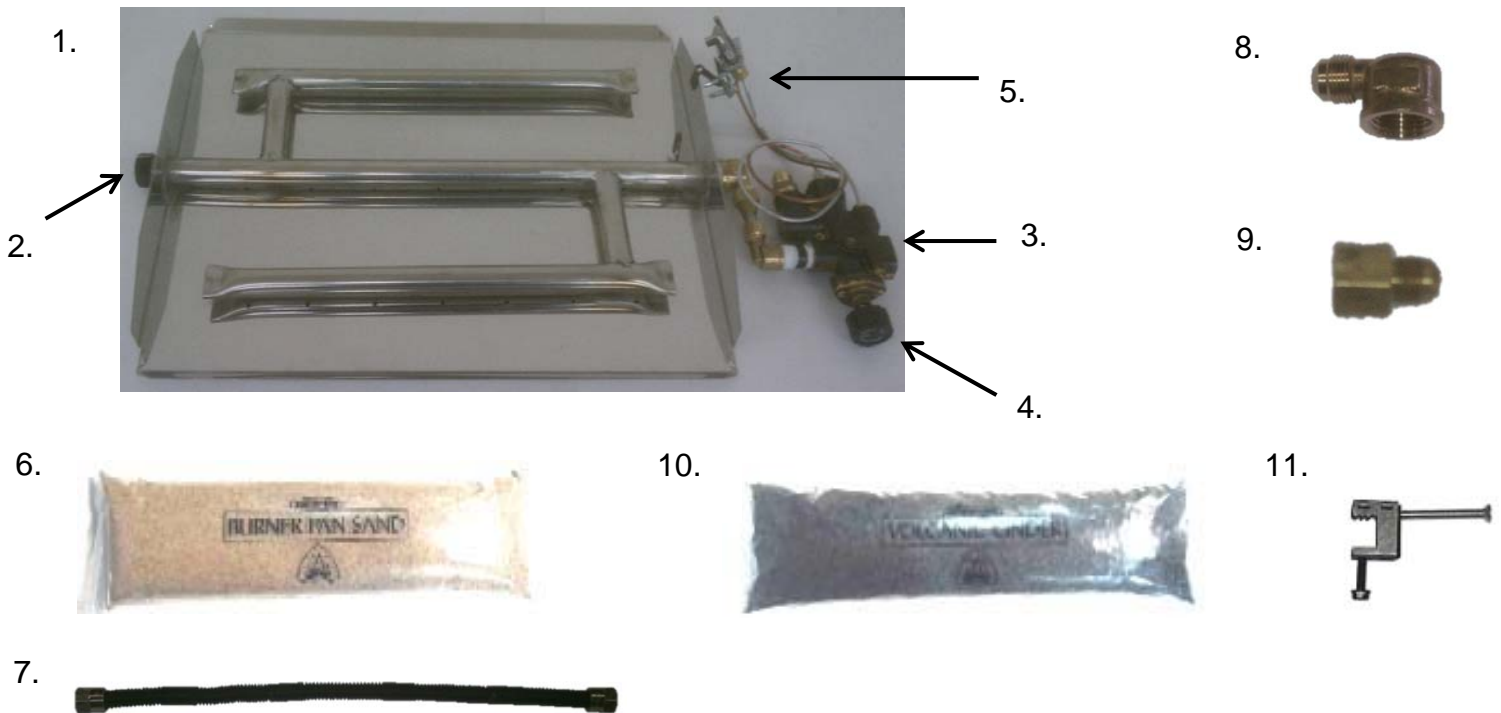

1. Make sure gas is shut off.
2. Connect either the brass reducing elbow (8) or brass reducing union (9) to your gas supply.
3. Connect the flex connector (7) from your brass reducer to the nipple on the back side of your valve.
4. Finally, make sure that all of your connections are tight before lighting.

INSTALLING STAINLESS STEEL "S" BURNER

PARTS LIST FOR LIQUID PROPANE WITH VALVE

<u>ITEM DESCRIPTION</u>	<u>18SNSB1B0</u>	<u>24SNSB1B0</u>	<u>30SNSB1B0</u>
1. S-Burner	SSSB18	SSSB24	SSSB30
2. Black pipe cap	CAP-8	CAP-8	CAP-8
3. Valve	CPC-C	CPC-C	CPC-C
4. Control knob	SPC-K	SPC-K	SPC-K
5. Thermocouple and pilot	RSTPB-18LP	RSTPB-18LP	RSTPB-18LP
6. Air mixer	AM-55	AM-55	AM-55
7. Flex connector	FCNW-18	FCNW-18	FCNW-18
8. Brass reducing union	46-6-8	46-6-8	46-6-8
9. Volcanic cinders (3/8")	VC	VC	VC
10. Damper stop	DS	DS	DS

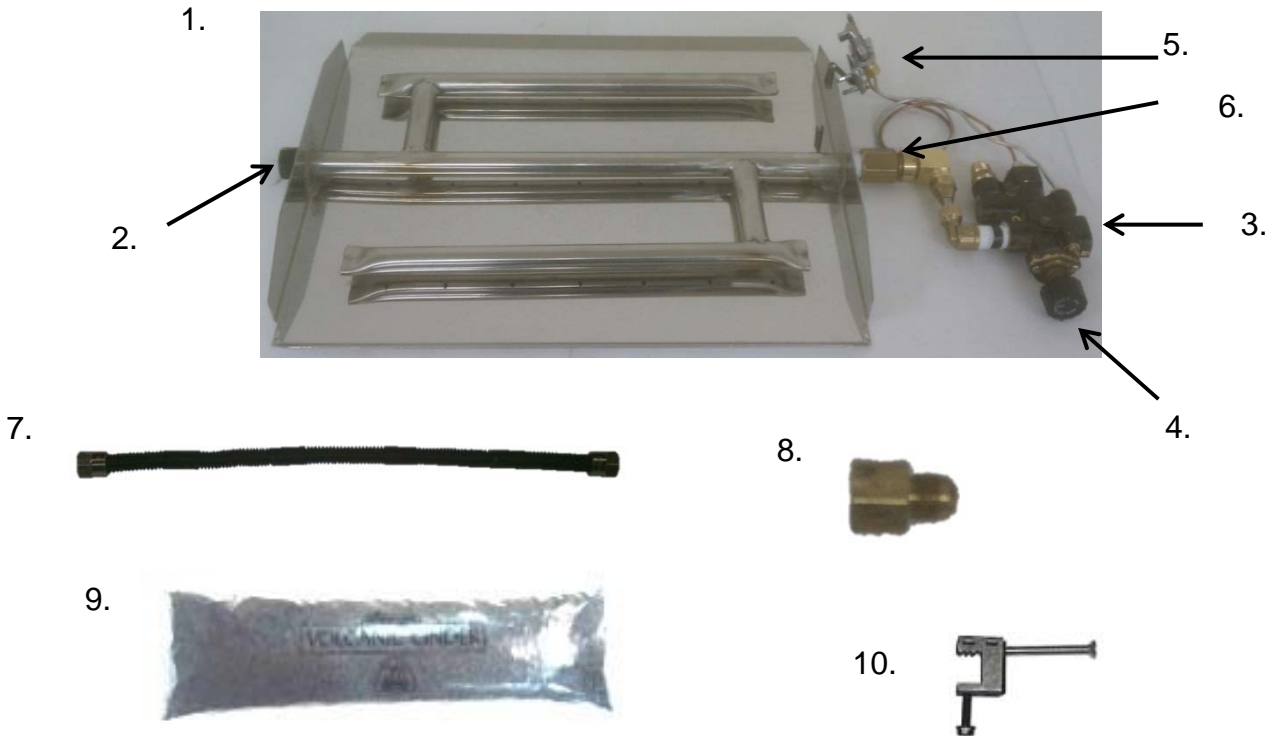

1. Make sure gas is shut off.
2. Connect brass reducing union (8) to your gas supply.
3. Connect the flex connector (7) from your brass reducing union (8) to the nipple on the back side of your valve.
4. Finally, make sure that all of your connections are tight before lighting.

DAMPER STOP

Attach the damper stop clamp to the fireplace damper blade. Position the clamp to prevent full closure of the fireplace damper blade. **See Figure 1**

If the damper stop provided does not fit, the installer shall install a permanent damper stop that will keep the damper open to a minimum of opening as determined in Table II.

CAUTION
THE DAMPER MUST BE FULLY OPEN WHEN OPERATING THE GAS APPLIANCE!

GLASS H-TUBE POSITIONING

1. Turn the gas **off**.
2. Remove old log lighter, ashes, and all other materials from the firebox.
3. Center the **Burner** on the fireplace floor with the burner pipe completely visible from the front. For best results, the Glass H-tube should be directly under the flue opening with a minimum of 4" from the front edge of the Glass H-tube to the fireplace opening. **See Figure 2**

STAINLESS "S" BURNER POSITIONING

1. Turn the gas off.
2. Remove old log lighter, ashes, and all other materials from the firebox.
3. Center the **Burner** on the fireplace floor with the burner pipe completely visible from the front. For best results, the Glass H-tube should be directly under the flue opening with a minimum of 4" from the front edge of the Glass H-tube to the fireplace opening. **See Figure 3**

GAS CONNECTION

1. The gas supply line should be 1/2" Inside Diameter (ID) up to 30 feet and 3/4" for longer distance.
2. Use the **gas connector (FCNW-18)** to connect gas supply to the **H-tube burner** and "**S**" burner.
3. Read lighting instructions. Light pilot on the "S" burner and check for leaks using soapy water. These controls are factory preset and will not normally require additional adjustment of the pilot flame. If field adjustment of the pilot flame is required, remove the pilot adjust cover screw to expose the adjusting screw. Turn the adjusting screw clockwise.

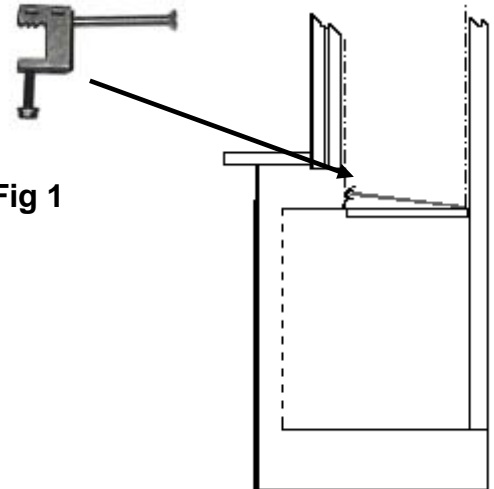

Fig 1

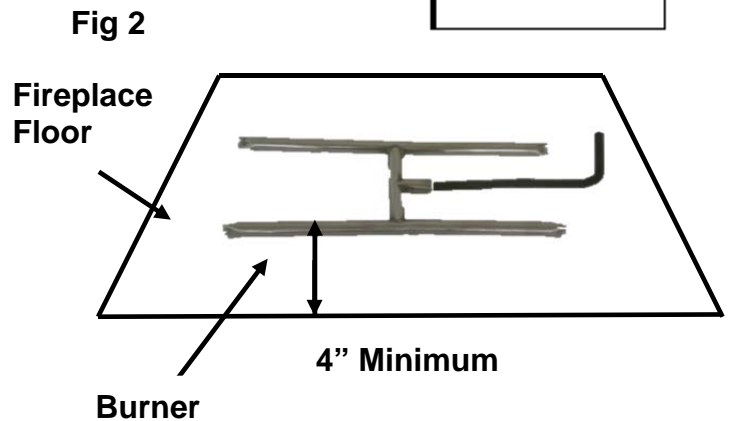

Fig 2

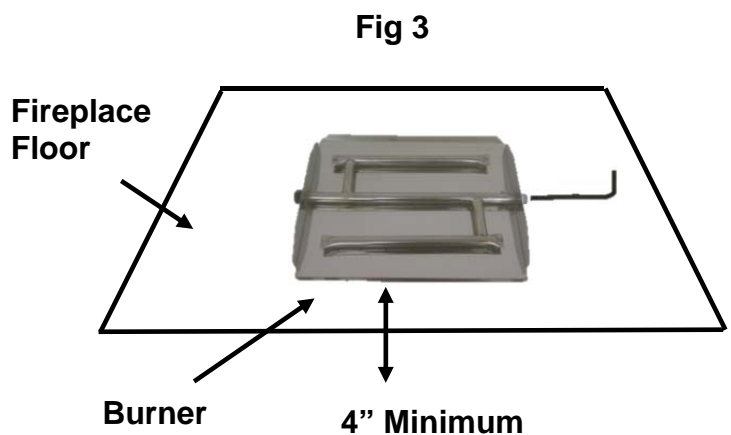
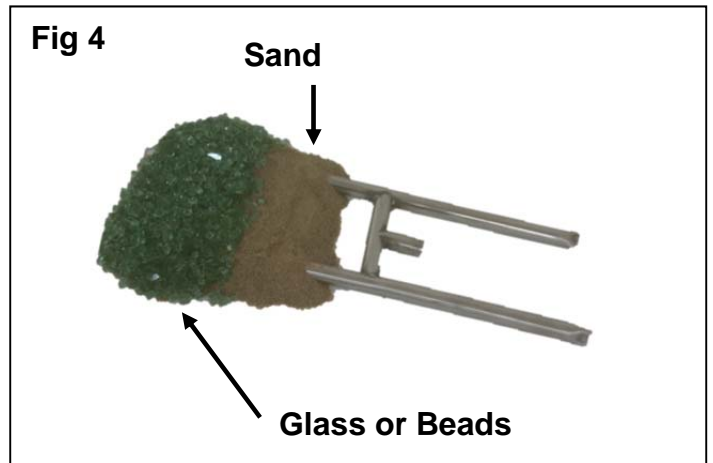

Fig 3

BURNER PAN MEDIA (Fig 4)

1. Cover the **Glass H-tube** with **Sand**. The Glass H-tube should be completely covered.
2. Light the gas and observe the flame for even distribution.
3. **The glass or beads** are placed over the sand. Place as much as desired over the area still allowing the gas comes through.



BURNER PAN MEDIA (Fig 5)

1. Fill the **S-burner** pan with **Sand** for NG and use only glass or beads only for LP. Sand level should be sloped evenly with the sides of the S burner should be completely full.
2. Light the gas and observe the flame for even distribution.
3. The glass or beads are placed over the sand or directly on the pan for LP. Place as much as desired over the area still allowing the gas to come through.

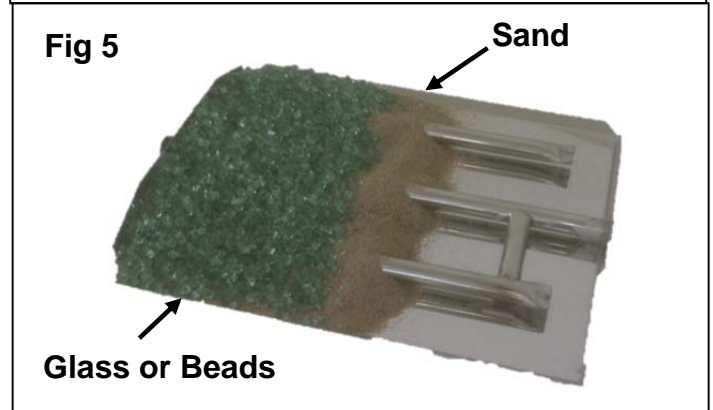

PILOT FLAME (Fig 6)

The pilot light should be checked periodically to assure proper flame. On the S-burner pans, the flame should be hanging on the side, directly over the middle burner. When turning the main burner on, the pilot flame should ignite the main gas within 4 seconds without creating a big poof, depending on the gas pressure.

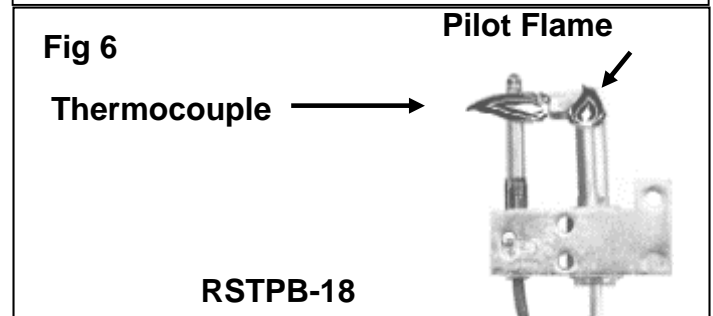

VOLCANIC CINDERS

The black volcanic cinders are used to cover the fireplace floor, fitting and tubing around the burner system. Although not functional, the black cinders act as a picture frame around the glass or beads.

FOR YOUR SAFETY

Do not use this appliance if any part has been underwater. Immediately call a qualified service technician to inspect the appliance and to replace any part of the system or gas control, which has been underwater. Keep this appliance clear and free from combustible materials, gasoline, and other flammable vapors and liquids.

FOR YOUR SAFETY READ BEFORE LIGHTING

WARNING: If you do not follow these instructions exactly, a fire or explosion may result causing property damage, personal injury or loss of life.

- A. This appliance has a pilot, which must be lit by hand. When lighting the pilot, follow these instructions exactly.
- B. **BEFORE LIGHTING** smell all around the appliance area for gas. Be sure to smell next to the floor because some gas is heavier than air and will settle on the floor.
- WHAT TO DO IF YOU SMELL GAS:**
1. Do not try to light any appliance.
 2. Do not touch any electric switch; do not use any phone in your building.
 3. Immediately call your gas supplier from a neighbor's phone. Follow the gas supplier's instructions.
 4. If you cannot reach your gas supplier, call the fire department.
- C. Use only your hand to push in or turn the gas control knob. Never use tools. If the knob will not push in or turn by hand, do not try to repair it. Call a qualified service technician.
- D. Do not use this appliance if any part has been under water. Immediately call a qualified service technician to inspect the appliance and to replace any part of the control system and any gas control, which has been underwater.

LIGHTING INSTRUCTIONS

1. STOP! Read the safety information above on this label.
2. Push in gas control knob slightly and turn clockwise to "OFF". 

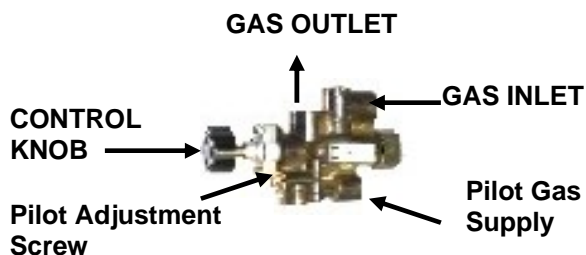

NOTE: Knob cannot be turned from "PILOT" to "OFF" unless knob is pushed in slightly. Do not force.

3. Wait five (5) minutes to clear out any gas. If you then smell gas, STOP! Follow "B" in the safety information above. If you don't smell gas, go to next step.

4. Find pilot – follow metal tube from the gas control behind the burner pan.

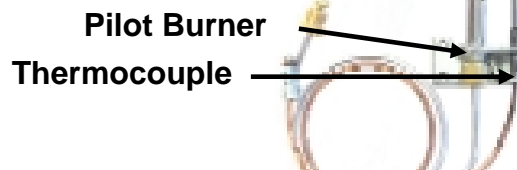

5. Turn knob on gas control counter-clockwise to "PILOT".
 6. Push in control knob all the way and hold in. Immediately light the pilot with a match. Continue to hold the control knob in for about one minute after the pilot is lit. Release knob and it will pop back up. Pilot should remain lit. If it goes out, repeat steps 3 – 7.
- * If knob does not pop up when released, stop and immediately call your service technician or gas supplier.
 - * If the pilot will not stay lit after several tries, turn the gas control knob to "OFF" and call your service technician or gas supplier.
7. Turn gas control knob counterclockwise to "ON".

LIGHTING INSTRUCTIONS

1. Turn knob clockwise from "ON" position to the "PILOT" position. Push in the gas control knob slightly and turn clockwise to "OFF".  Do not force knob.

LIMITED WARRANTY

Refractory Logs

Hargrove gas logs carry a limited lifetime warranty against any manufactured defect or breakage. This warranty does not cover breakage caused by excessive handling once installed and fired. Contact Customer Service for warranty claim details.

Burner & Grate

If the burner or grate fails due to deterioration within five (5) years of the verified purchase date, contact Customer Service for warranty claim details.

Valves, Remote Controls, & Switching Devices

All valves, remote controls and switching devices are warranted against manufacturing defects which appear within two (2) years of the verified purchase date. Warranty does not cover products that have been damaged by misuse from overheating. Before any product is returned a Return Goods Authorization number (RGA) must be issued by the Customer Service Department. All returns must be accompanied by an explanation of the problem and all necessary parts.

All Other Parts

If any assembled part should fail to operate or be found defective which appear within two years of the verified purchase date, contact Customer Service for warranty claim details

Buyer shall notify Customer Service of any defect covered by this warranty no later than thirty (30) days after defect is discovered. Failure to provide notice within thirty (30) days shall void the limited warranty.

WHAT IS NOT COVERED

1. Removal and reinstallation costs.
2. Labor costs for replacement or repairs.
3. Transportation or shipping cost.
4. The cost of a service call to diagnose trouble.
5. Painted Surfaces.
6. Damage or defect caused by improper installation, accident, misuse, abuse, alteration, or authorized service technician.
7. Replacement of burner or combustion chamber resulting from improper storage of the appliance.

LIMITATIONS AND EXCLUSIONS

1. No one has authority to add to or vary this limited warranty, or to create for Hargrove Manufacturing Corporation any other obligation or liability in connection with this appliance.
2. Any implied warranty applicable to this appliance is limited in duration to the same period of time as this written Warranty. Some states do not allow limitations on how long an implied warranty lasts, so the above limitations may not apply to you.
3. HARGROVE MANUFACTURING CORPORATION WILL NOT BE LIABLE FOR INCIDENTAL, CONSEQUENTIAL, SPECIAL OR CONTINGENT DAMAGES YOU MIGHT SUFFER AS A RESULT OF A CLAIM UNDER THIS WRITTEN WARRANTY OR ANY IMPLIED WARRANTY. Some states do not allow the exclusion or limitation of incidental or consequential damages, so the above limitations or exclusion may not apply to you.
4. This warranty applies only to the original purchaser and may not be transferred or assigned.
5. If you cannot verify the purchase date of the appliance, the warranty period will begin on the date of which the appliance was manufactured.
6. Replacement or repair parts are warranted for the remaining period of the original part warranty. Warranty parts must be obtained through authorized dealers of this product who will provide original factory replacement parts. Failure to use original factory replacement parts voids this warranty.
7. The maximum liability of Hargrove Mfg Corp. in connection with this limited warranty shall not in any case exceed the contract price paid for the product claimed to be defective or unsuitable.
8. Purchaser or user agrees to hold Hargrove Mfg Corp. harmless from any and all claims by the buyer as a result of injury or damage to an ultimate user or other person caused by the product sold herein by the seller to the buyer, whether the injury or damage results from the assembly, installation, operation, shipment, storage, or manufacture of this product. Hargrove Mfg Corp. makes no warranties, expressed or implied, other than those expressly stated herein.

YOUR DUTIES

This appliance must be installed by a qualified installer, operated and maintained in accordance with all applicable codes and the instructions furnished with the appliance. You must provide a receipt verifying the purchase date of the appliance when making a warranty claim with the dealer from which the appliance was purchased.

This warranty gives you specific legal rights, and you may also have other rights, which vary from state to state.

CONTACT INFO: Hargrove Gas Logs

207 Wellston Park Rd. – Sand Springs, OK 74063

Toll Free – (800)725-4166

www.hargrovegaslogs.com

Customer Service hours: 9:00am to 4:00pm CST